

CONTOARE DE ENERGIE

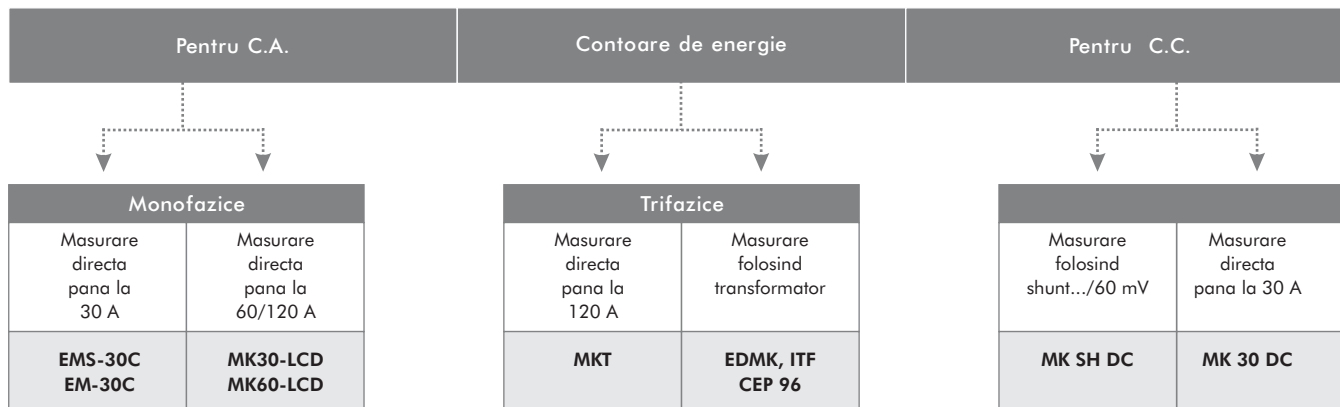

PENTRU CURENT ALTERNATIV

Contor de energie trifazic - masurare prin transformator

Tip	Cod	Modul	Ecran	Tarif	Comunicatie	Marimi masurate
EDMk - pe sina DIN - alimentare 230V c.a. -						
EDMk-ITF-C2	[*] M31741		LCD	1	-	kW·h, kvarL·h, kvarC·h
EDM3k-ITF-C2	[*] M31743		LCD	3	-	kW·h, kvarL·h, kvarC·h
EDMk-ITF-RS485	[*] M31751		LCD	1	RS-485	kW·h, kvarL·h, kvarC·h
EDMk-MC, Sistem de masurare eficient						
EDMk-MC-ITF-C2 (*)	[*] M31771	3	LCD	1	-	
EDMk-MC-ITFRS485-C2(*)	[*] M31781	3	LCD	1	RS-485	

(*) Valabil numai cu sursa de alimentare 230V c.a. Accesorii pentru prindere pe fata panoului M5ZZF1

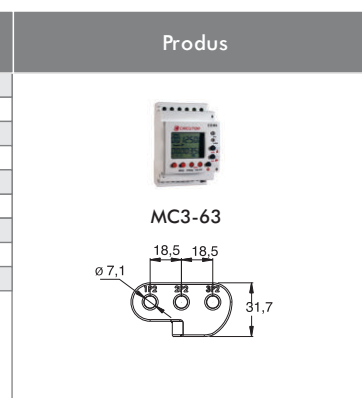

Transformatoare de curent MC1 si MC3

Tip	Cod	A max.	Valori	Class 0,5 Power	Masura	Diametru interior
MC3-63	[*] M73121	63	-	0,1 V·A	3 faze	7,1 mm
MC3-125	[*] M73122	125	-	0,1 V·A	3 faze	14,6 mm
MC1-20-150/200/250	[*] M73113	250	150/200/250	0,25 V·A	1 faza	20 mm
MC1-30-250/400/500	[*] M73114	500	250/400/500	0,25 V·A	1 faza	30 mm

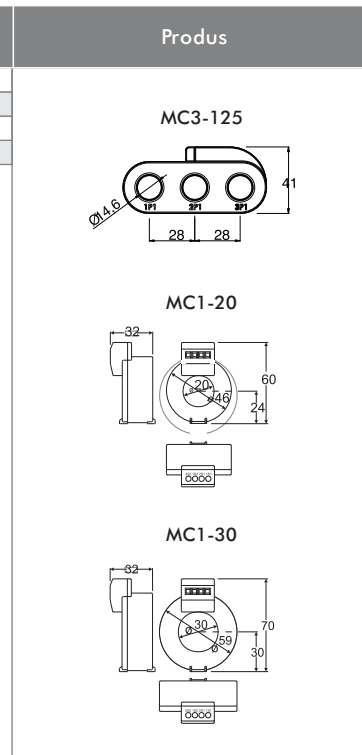



Transformatoarele MC sunt compatibile numai cu aparatele EDMk-MC, CVM MINI-MC si CVM NRG96-MC.



Combinatia este formata din: EDMk-MC + 1 MC3 (sau 3 x transformatoare MC1).



Contor trifazic de energie - conectare directa

Tip	Cod	Curent Nominal	Modul	Display	Tarif	Intrari izolate galvanic	Unitati masura	Produs
Seria MK-63M - pe sina DIN - alimentare 400V c.a.								
MK-63M ARON-400	[*] M30310	63 (120) A		Mecanic	1	-	kW·h	
MK-63M ARON-230	[*] M30310002	63 (120) A		Mecanic	1	-	kW·h	
Seria MKD - pe sina DIN - alimentare 90...500 V ca (intre L1 si L2)								
MKD-ITF-C2	[*] M33000	40 (120) A	6	Digital	1	-/2	kW·h, kvar·h	
MKD-ITFRS485-I2-C2	[*] M33011	40 (120) A	6	Digital	3	2 / 2	kW·h, kvar·h	

Contor monofazic de energie - conectare directa

Tip	Cod	Curent Nominal	Modul	Display	Unitati masura	Comunicatie	Produs
Seria EM - pe sina DIN - alimentare 230 V							
EMS30 - C	[*] M31611	5 (30) A	1	Mecanic	kW·h	-	
EM30 - C	[*] M30811	5 (30) A	2	Mecanic	kW·h	-	
MK series- pe sina DIN- alimentare 230 V							
MK-30 M	[*] M30110	30 (60) A	4	Mecanic	kW·h	-	
MK-60 M	[*] M30210	60 (120) A	4	Mecanic	kW·h	-	
MK-30 LCD	[*] M30120	30 (60) A	4	Digital	kW·h, V, A, W	-	
MK-60 LCD	[*] M30220	60 (120) A	4	Digital	kW·h, V, A, W	-	
MK-30 LCD-RS485	[*] M30121	30 (60) A	4	Digital	kW·h, V, A, W	RS-485	
MK-60 LCD-RS485	[*] M30221	60 (120) A	4	Digital	kW·h, V, A, W	RS-485	

PENTRU CURENT CONTINUU
Contor trifazic de energie - conectare directa

Tip	Cod	Masura	Modul	Display	Tarif	Unitati masura	Produs
MK-DC series - pe sina DIN- alimentare 230 V alimentare 400V c.a.							
MK30-DC	[*] M30300	masurare directa 30 A dc	2	LED	1	kW·h, V, A, kW	
MK-SH DC	[*] M30400	masurare cu shunt .../ 60 mV	2	LED	1	kW·h, V, A, kW	

Ideal pentru aplicatii fotovoltaice

ACCESORII

Tip	Cod	Produs
Centralizator de impulsuri		
LM50-TCP 19200 bps	[*] M31531	Centralizator 50 intrari (Ethernet input, Modbus/TCP protocol)
LM50-TCP 9600 bps	[*] M31541	Centralizator 50 intrari (Ethernet input, Modbus/TCP protocol)
LM24-M	[*] M31520	Centralizator 24 intrari (Modbus/TCP protocol)
Converter		
Conv. RS-232/485	[*] M54020	RS-232/485 converter inteligent (RTS control)
Ampl. RS-485	[*] M54080	RS-485 Amplificator / repetor
TCP2RS-RTU	[*] M54031	RS-232/485 converter / Ethernet Modbus/RTU (transparent)
TCP2RS-TCP	[*] M54032	RS-232/485 converter / Ethernet Modbus/TCP
Software		
PowerStudio	[*] M90211	
PowerStudioScada	[*] M90231	Software cu HASP licenta USB

[*] Livrare imediata